

Velmex Price List Part 1: Manual Assemblies

January 5, 2009

UniSlide® Series A15 with standard 1.5" length slider

Read down for travel, across for desired lead screw and price. Call Velmex for longer units.

A15 Free Sliding Models

Travel Inches	Catalog Number	Base Length	Price with Std. Length Slider
1.5"	A1503A-S1.5	3"	\$78
4.5"	A1506A-S1.5	6"	\$90
7.5"	A1509A-S1.5	9"	\$106
10.5"	A1512A-S1.5	12"	\$123
13.5"	A1515A-S1.5	15"	\$139
16.5"	A1518A-S1.5	18"	\$156
19.5"	A1521A-S1.5	21"	\$174
22.5"	A1524A-S1.5	24"	\$193
25.5"	A1527A-S1.5	27"	\$218



This price list may not be up to date. Contact Velmex for latest price

A15 Screw Drive Models

Travel Inches	Lead Screw Pitch				Base Length	Price
	40 turns inch	20 turns inch	10 turns cm.	5 turns cm.		
1.5"	A1503C-S1.5	A1503B-S1.5	A1503K1-S1.5	A1503K2-S1.5	3"	\$154
4.5"	A1506C-S1.5	A1506B-S1.5	A1506K1-S1.5	A1506K2-S1.5	6"	\$172
7.5"	A1509C-S1.5	A1509B-S1.5	A1509K1-S1.5	A1509K2-S1.5	9"	\$192
10.5"	A1512C-S1.5	A1512B-S1.5	A1512K1-S1.5	A1512K2-S1.5	12"	\$211
13.5"	A1515C-S1.5	A1515B-S1.5	A1515K1-S1.5	A1515K2-S1.5	15"	\$231



A15 Graduated Knob Models

Travel Inches	40 turns inch	20 turns inch	10 turns cm.	5 turns cm.	Base Length	Price
1.5"	A1503P40-S1.5	A1503P20-S1.5	A1503Q1-S1.5	A1503Q2-S1.5	3"	\$262
4.5"	A1506P40-S1.5	A1506P20-S1.5	A1506Q1-S1.5	A1506Q2-S1.5	6"	\$279
7.5"	A1509P40-S1.5	A1509P20-S1.5	A1509Q1-S1.5	A1509Q2-S1.5	9"	\$303
10.5"	A1512P40-S1.5	A1512P20-S1.5	A1512Q1-S1.5	A1512Q2-S1.5	12"	\$321



Knob design varies with screw pitch

A15 Scale and Vernier Screw Drive Models

Travel Inches	40 turns inch	20 turns inch	10 turns cm.	5 turns cm.	Base Length	Price
1.5"	A1503CE-S1.5	A1503BE-S1.5	A1503K1M-S1.5	A1503K2M-S1.5	3"	\$227
4.5"	A1506CE-S1.5	A1506BE-S1.5	A1506K1M-S1.5	A1506K2M-S1.5	6"	\$258
7.5"	A1509CE-S1.5	A1509BE-S1.5	A1509K1M-S1.5	A1509K2M-S1.5	9"	\$290
10.5"	A1512CE-S1.5	A1512BE-S1.5	A1512K1M-S1.5	A1512K2M-S1.5	12"	\$324



A15 Rapid Advance Model D, DE/DM with Scale and Vernier and GE/GM with Micrometer, all with limited fine adjust

Travel Inches	with Scale and Vernier				with Micrometer Head				Base Length
	Model D	Price	Model DE or DM	Price	Model GE	Model GM	Price		
1.5"	A1503D-S1.5	\$216	A1503DE-S1.5	\$288	A1503GE-S1.5	A1503GM-S1.5	\$326	3"	
4.5"	A1506D-S1.5	\$236	A1506DE-S1.5	\$320	A1506GE-S1.5	A1506GM-S1.5	\$338	6"	
7.5"	A1509D-S1.5	\$258	A1509DE-S1.5	\$356	A1509GE-S1.5	A1509GM-S1.5	\$352	9"	
10.5"	A1512D-S1.5	\$282	A1512DE-S1.5	\$392	A1512GE-S1.5	A1512GM-S1.5	\$384	12"	



A15 Left-Right Screw Motion UniSlides

Slider Separation	Base length L	40 turns inch		20 turns inch		Price
		Model	Price	Model	Price	
3	6	A1506C-S1.5-LR	\$302	A1506B-S1.5-LR	\$323	
6	9	A1509C-S1.5-LR	\$347	A1509B-S1.5-LR	\$371	
9	12	A1512C-S1.5-LR	\$398	A1512B-S1.5-LR		
12	15	A1515C-S1.5-LR		A1515B-S1.5-LR		
15	18	A1518C-S1.5-LR		A1518B-S1.5-LR		



For Options see page 7

Product Weight

Call Velmex for prices of longer UniSlide Assemblies

Series A25 with standard 2.5" long slider

Read down for travel, across for desired lead screw and price. Call Velmex for longer units.

A25 Free Sliding Models

Travel Inches	Catalog Number	Base Length	Price with Std. Length Slider
1.5"	A2504A-S2.5	4"	\$129
3.5"	A2506A-S2.5	6"	\$137
6.5"	A2509A-S2.5	9"	\$156
9.5"	A2512A-S2.5	12"	\$178
12.5"	A2515A-S2.5	15"	\$200
15.5"	A2518A-S2.5	18"	\$223
18.5"	A2521A-S2.5	21"	\$251
21.5"	A2524A-S2.5	24"	\$281
24.5"	A2527A-S2.5	27"	\$311



**For Options
see page 7**

Download our current
Catalog

Product Weight

A25 Screw Drive Models

Travel Inches	Lead Screw Pitch				Base Length	Price	
	40 turns inch	20 turns inch	10 turns inch	5 turns cm.			
1.5"	A2504C-S2.5	A2504B-S2.5		A2504K1-S2.5	4"	\$216	
3.5"	A2506C-S2.5	A2506B-S2.5		A2506K1-S2.5	6"	\$238	
6.5"	A2509C-S2.5	A2509B-S2.5		A2509K1-S2.5	9"	\$260	
9.5"	A2512C-S2.5	A2512B-S2.5		A2512K1-S2.5	12"	\$288	
12.5"	A2515C-S2.5	A2515B-S2.5		A2515K1-S2.5	15"	\$313	
15.5" to 24"	see the next block of Model Numbers.						



1.5"			A2504W1-S2.5			4"	\$261
3.5"			A2506W1-S2.5			6"	\$285
6.5"			A2509W1-S2.5			9"	\$310
9.5"			A2512W1-S2.5			12"	\$335
12.5"			A2515W1-S2.5			15"	\$363
15.5"	A2518C-S2.5	A2518B-S2.5	A2518W1-S2.5	A2518K1-S2.5	A2518K2-S2.5	18"	\$387
18.5"	A2521C-S2.5	A2521B-S2.5	A2521W1-S2.5	A2521K1-S2.5	A2521K2-S2.5	21"	\$421
21.5"	A2524C-S2.5	A2524B-S2.5	A2524W1-S2.5	A2524K1-S2.5	A2524K2-S2.5	24"	\$451
24.5"	A2527C-S2.5	A2527B-S2.5	A2527W1-S2.5	A2527K1-S2.5	A2527K2-S2.5	27"	\$483

A25 Graduated Knob Models

Travel Inches	40 turns		20 turns		10 turns		Base Length	Price
	inch	inch	inch	inch	cm.	cm.		
1.5"	A2504P40-S2.5	A2504P20-S2.5			A2504Q1-S2.5	A2504Q2-S2.5	4"	\$390
3.5"	A2506P40-S2.5	A2506P20-S2.5			A2506Q1-S2.5	A2506Q2-S2.5	6"	\$409
6.5"	A2509P40-S2.5	A2509P20-S2.5			A2509Q1-S2.5	A2509Q2-S2.5	9"	\$430
9.5"	A2512P40-S2.5	A2512P20-S2.5			A2512Q1-S2.5	A2512Q2-S2.5	12"	\$452
1.5"					A2504P10-S2.5		4"	\$418
3.5"					A2506P10-S2.5		6"	\$436
6.5"					A2509P10-S2.5		9"	\$457
9.5"					A2512P10-S2.5		12"	\$479

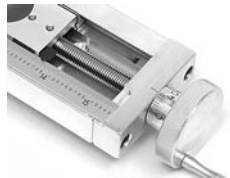

Knob design varies
with screw pitch

A25 Scale and Vernier Screw Drive Models

Travel Inches	40 turns		20 turns		10 turns		Base Length	Price
	inch	inch	inch	inch	cm.	cm.		
1.5"	A2504CE-S2.5	A2504BE-S2.5			A2504K1M-S2.5	A2504K2M-S2.5	4"	\$304
3.5"	A2506CE-S2.5	A2506BE-S2.5			A2506K1M-S2.5	A2506K2M-S2.5	6"	\$336
6.5"	A2509CE-S2.5	A2509BE-S2.5			A2509K1M-S2.5	A2509K2M-S2.5	9"	\$373
9.5"	A2512CE-S2.5	A2512BE-S2.5			A2512K1M-S2.5	A2512K2M-S2.5	12"	\$409
12.5"	A2515CE-S2.5	A2515BE-S2.5			A2515K1M-S2.5	A2515K2M-S2.5	15"	\$443
1.5"					A2504W1E-S2.5		4"	\$358
3.5"					A2506W1E-S2.5		6"	\$393
6.5"					A2509W1E-S2.5		9"	\$428
9.5"					A2512W1E-S2.5		12"	\$466
12.5"					A2515W1E-S2.5		15"	\$504



A25 Rapid Advance Model D, DE/DM with Scale and Vernier and GE/GM with Micrometer, all with limited fine adjust

Travel Inches	with Scale and Vernier				with Micrometer Head				
	Model D	Price	Model DE or DM		Model GE	Model GM		Base Length	
			Model	Price		Model	Price		
1.5"	A2504D-S2.5	\$295	A2504DE-S2.5	A2504DM-S2.5	\$383	A2504GE-S2.5	A2504GM-S2.5	\$418	4"
3.5"	A2506D-S2.5	\$319	A2506DE-S2.5	A2506DM-S2.5	\$410	A2506GE-S2.5	A2506GM-S2.5	\$442	6"
6.5"	A2509D-S2.5	\$346	A2509DE-S2.5	A2509DM-S2.5	\$439	A2509GE-S2.5	A2509GM-S2.5	\$474	9"
9.5"	A2512D-S2.5	\$375	A2512DE-S2.5	A2512DM-S2.5	\$470	A2512GE-S2.5	A2512GM-S2.5	\$504	12"



Knob design varies
with Model

A25 Full Travel, Unlimited Fine Adjust UniSlide Assemblies Model H

Rapid Advance

Rapid Advance with Scale and Vernier



Travel Inches	Model		Price	Model		Price	Base Length
	H20	H1		HE	HM		
1.5"	A2504H20-S2.5	A2504H1-S2.5	\$368	A2504HE-S2.5	A2504HM-S2.5	\$478	4"
3.5"	A2506H20-S2.5	A2506H1-S2.5	\$391	A2506HE-S2.5	A2506HM-S2.5	\$504	6"
6.5"	A2509H20-S2.5	A2509H1-S2.5	\$428	A2509HE-S2.5	A2509HM-S2.5	\$542	9"
9.5"	A2512H20-S2.5	A2512H1-S2.5	\$469	A2512HE-S2.5	A2512HM-S2.5	\$580	12"
12.5"	A2515H20-S2.5	A2515H1-S2.5	\$512				

A25 Left-Right Screw Motion UniSlides



Slider Separation	Base length	40 turns		Price
		inch	inch	
1	6	A2506C-S2.5-LR	A2506B-S2.5-LR	\$456
4	9	A2509C-S2.5-LR	A2509B-S2.5-LR	\$494
7	12	A2512C-S2.5-LR	A2512B-S2.5-LR	\$531
10	15	A2515C-S2.5-LR	A2515B-S2.5-LR	\$575
13	18	A2518C-S2.5-LR	A2518B-S2.5-LR	\$619

Call Velmex for prices of longer UniSlide Assemblies

Series A40 with standard 4" long slider

Read down for travel, across for desired lead screw and price. Call Velmex for longer units.

A40 Free Sliding Models

Travel Inches	Catalog Number	Base Length	Price with Std. Length Slider
2"	A4006A-S4	6"	\$194
5"	A4009A-S4	9"	\$220
8"	A4012A-S4	12"	\$249
11"	A4015A-S4	15"	\$282
14"	A4018A-S4	18"	\$319
17"	A4021A-S4	21"	\$361
20"	A4024A-S4	24"	\$407
23"	A4027A-S4	27"	\$461
26"	A4030A-S4	30"	\$521
29"	A4033A-S4	33"	\$537
32"	A4036A-S4	36"	\$571
35"	A4039A-S4	39"	\$588



For Options
see page 7

Download our current
Catalog

Product Weight

A40 Screw Drive Models

Travel Inches	Lead Screw Pitch						Base Length	Price
	40 turns inch	20 turns inch	10 turns inch	5 turns inch	10 turns cm.	5 turns cm.		
2"	A4006C-S4	A4006B-S4	A4006W1-S4	A4006W2-S4	A4006K1-S4	A4006K2-S4	6"	\$305
5"	A4009C-S4	A4009B-S4	A4009W1-S4	A4009W2-S4	A4009K1-S4	A4009K2-S4	9"	\$337
8"	A4012C-S4	A4012B-S4	A4012W1-S4	A4012W2-S4	A4012K1-S4	A4012K2-S4	12"	\$371
11"	A4015C-S4	A4015B-S4	A4015W1-S4	A4015W2-S4	A4015K1-S4	A4015K2-S4	15"	\$409
14"	A4018C-S4	A4018B-S4	A4018W1-S4	A4018W2-S4	A4018K1-S4	A4018K2-S4	18"	\$450
17"	A4021C-S4	A4021B-S4	A4021W1-S4	A4021W2-S4	A4021K1-S4	A4021K2-S4	21"	\$495
20"	A4024C-S4	A4024B-S4	A4024W1-S4	A4024W2-S4	A4024K1-S4	A4024K2-S4	24"	\$545
23"	A4027C-S4	A4027B-S4	A4027W1-S4	A4027W2-S4	A4027K1-S4	A4027K2-S4	27"	\$600
26"	A4030C-S4	A4030B-S4	A4030W1-S4	A4030W2-S4	A4030K1-S4	A4030K2-S4	30"	\$661
29"	A4033C-S4	A4033B-S4	A4033W1-S4	A4033W2-S4	A4033K1-S4	A4033K2-S4	33"	\$688
32"	A4036C-S4	A4036B-S4	A4036W1-S4	A4036W2-S4	A4036K1-S4	A4036K2-S4	36"	\$716
35"	A4039C-S4	A4039B-S4	A4039W1-S4	A4039W2-S4	A4039K1-S4	A4039K2-S4	39"	\$743
38"	A4042C-S4	A4042B-S4	A4042W1-S4	A4042W2-S4	A4042K1-S4	A4042K2-S4	42"	\$769

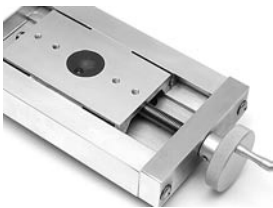

A40 Graduated Knob Models

Travel Inches	40 turns inch	20 turns inch	10 turns inch	5 turns inch	10 turns cm.	5 turns cm.	Base Length	Price
2"	A4006P40-S4	A4006P20-S4	A4006P10-S4	A4006P5-S4	A4006Q1-S4	A4006Q2-S4	6"	\$482
5"	A4009P40-S4	A4009P20-S4	A4009P10-S4	A4009P5-S4	A4009Q1-S4	A4009Q2-S4	9"	\$518
8"	A4012P40-S4	A4012P20-S4	A4012P10-S4	A4012P5-S4	A4012Q1-S4	A4012Q2-S4	12"	\$557
11"	A4015P40-S4	A4015P20-S4	A4015P10-S4	A4015P5-S4	A4015Q1-S4	A4015Q2-S4	15"	\$600
14"	A4018P40-S4	A4018P20-S4	A4018P10-S4	A4018P5-S4	A4018Q1-S4	A4018Q2-S4	18"	\$644
17"	A4021P40-S4	A4021P20-S4	A4021P10-S4	A4021P5-S4	A4021Q1-S4	A4021Q2-S4	21"	\$692



Knob design varies
with screw pitch

A40 Scale and Vernier Models

Travel Inches	40 turns inch	20 turns inch	10 turns inch	5 turns inch	10 turns cm.	5 turns cm.	Base Length	Price.
2"	A4006CE-S4	A4006BE-S4	A4006W1E-S4	A4006W2E-S4	A4006K1M-S4	A4006K2M-S4	6"	\$384
5"	A4009CE-S4	A4009BE-S4	A4009W1E-S4	A4009W2E-S4	A4009K1M-S4	A4009K2M-S4	9"	\$432
8"	A4012CE-S4	A4012BE-S4	A4012W1E-S4	A4012W2E-S4	A4012K1M-S4	A4012K2M-S4	12"	\$479
11"	A4015CE-S4	A4015BE-S4	A4015W1E-S4	A4015W2E-S4	A4015K1M-S4	A4015K2M-S4	15"	\$534
14"	A4018CE-S4	A4018BE-S4	A4018W1E-S4	A4018W2E-S4	A4018K1M-S4	A4018K2M-S4	18"	\$587

A40 Full Travel, Limited Travel Fine Adjust Model D, DE/DM and Model GE/GM

Travel Inches	with Scale and Vernier				with Micrometer Head			Base Length	
	Model D	Price	Model DE	Model DM	Price	Model GE	Model GM.....		Price
2"	A4006D-S4	\$372	A4006DE-S4	A4006DM-S4	\$445	A4006GE-S4	A4006GM-S4	\$472	6"
5"	A4009D-S4	\$426	A4009DE-S4	A4009DM-S4	\$499	A4009GE-S4	A4009GM-S4	\$515	9"
8"	A4012D-S4	\$479	A4012DE-S4	A4012DM-S4	\$552	A4012GE-S4	A4012GM-S4	\$558	12"
11"	A4015D-S4	\$539	A4015DE-S4	A4015DM-S4	\$612	A4015GE-S4	A4015GM-S4	\$606	15"

A40 Full Travel, Unlimited Fine Adjust Model H and HE/HM

Travel Inches	Rapid Advance			Rapid Advance with Scale and Vernier			Base Length
	Model H20	Model H1	Price	Model HE	Model HM	Price	
2"	A4006H20-S4	A4006H1-S4	\$568	A4006HE-S4	A4006HM-S4	\$641	6"
5"	A4009H20-S4	A4009H1-S4	\$610	A4009HE-S4	A4009HM-S4	\$683	9"
8"	A4012H20-S4	A4012H1-S4	\$653	A4012HE-S4	A4012HM-S4	\$726	12"
11"	A4015H20-S4	A4015H1-S4	\$702	A4015HE-S4	A4015HM-S4	\$775	15"
14"	A4018H20-S4	A4018H1-S4	\$750				
17"	A4021H20-S4	A4021H1-S4	\$803				

A40 Left-Right Screw Motion UniSlides

Sepera- tion	Base		Price
	L	Price	
1	9	A4009C-S4-LR	\$603
4	12	A4012C-S4-LR	\$636
7	15	A4015C-S4-LR	\$669
10	18	A4018C-S4-LR	\$707
13	21	A4021C-S4-LR	\$745
16	24	A4024C-S4-LR	\$788

Call Velmex for prices of longer UniSlide Assemblies

Series A60 with standard 6" long slider

Read down for travel, across for desired lead screw and price. Call Velmex for longer units.

A60 Free Sliding Models

Travel Inches	Catalog Number	Base Length	Price
3"	A6009A-S6	9"	\$304
6"	A6012A-S6	12"	\$339
9"	A6015A-S6	15"	\$381
12"	A6018A-S6	18"	\$425
15"	A6021A-S6	21"	\$476
18"	A6024A-S6	24"	\$532
21"	A6027A-S6	27"	\$595
24"	A6030A-S6	30"	\$666
27"	A6033A-S6	33"	\$743
30"	A6036A-S6	36"	\$830
33"	A6039A-S6	39"	\$918
36"	A6042A-S6	42"	\$1,006
39"	A6045A-S6	45"	\$1,030
42"	A6048A-S6	48"	\$1,052
45"	A6051A-S6	51"	\$1,076
48"	A6054A-S6	54"	\$1,100
51"	A6057A-S6	57"	\$1,123
54"	A6060A-S6	60"	\$1,147
57"	A6063A-S6	63"	\$1,171
60"	A6066A-S6	66"	\$1,191

For Options
see page 7

Download our current
Catalog

Product Weight

A60 Screw Drive Models

Lead Screw Pitch

Travel Inches	40 turns inch	20 turns inch	10 turns inch	5 turns inch	10 turns cm.	5 turns cm.	Base Length	Price
3"	A6009C-S6	A6009B-S6	A6009W1-S6	A6009W2-S6	A6009K1-S6	A6009K2-S6	9"	\$460
6"	A6012C-S6	A6012B-S6	A6012W1-S6	A6012W2-S6	A6012K1-S6	A6012K2-S6	12"	\$503
9"	A6015C-S6	A6015B-S6	A6015W1-S6	A6015W2-S6	A6015K1-S6	A6015K2-S6	15"	\$550
12"	A6018C-S6	A6018B-S6	A6018W1-S6	A6018W2-S6	A6018K1-S6	A6018K2-S6	18"	\$603
15"	A6021C-S6	A6021B-S6	A6021W1-S6	A6021W2-S6	A6021K1-S6	A6021K2-S6	21"	\$660
18"	A6024C-S6	A6024B-S6	A6024W1-S6	A6024W2-S6	A6024K1-S6	A6024K2-S6	24"	\$712
21"	A6027C-S6	A6027B-S6	A6027W1-S6	A6027W2-S6	A6027K1-S6	A6027K2-S6	27"	\$780
24"	A6030C-S6	A6030B-S6	A6030W1-S6	A6030W2-S6	A6030K1-S6	A6030K2-S6	30"	\$853
27"	A6033C-S6	A6033B-S6	A6033W1-S6	A6033W2-S6	A6033K1-S6	A6033K2-S6	33"	\$933
30"	A6036C-S6	A6036B-S6	A6036W1-S6	A6036W2-S6	A6036K1-S6	A6036K2-S6	36"	\$1,024
33"	A6039C-S6	A6039B-S6	A6039W1-S6	A6039W2-S6	A6039K1-S6	A6039K2-S6	39"	\$1,115
36"	A6042C-S6	A6042B-S6	A6042W1-S6	A6042W2-S6	A6042K1-S6	A6042K2-S6	42"	\$1,206
39"	A6045C-S6	A6045B-S6	A6045W1-S6	A6045W2-S6	A6045K1-S6	A6045K2-S6	45"	\$1,241
42"	A6048C-S6	A6048B-S6	A6048W1-S6	A6048W2-S6	A6048K1-S6	A6048K2-S6	48"	\$1,275
45"	A6051C-S6	A6051B-S6	A6051W1-S6	A6051W2-S6	A6051K1-S6	A6051K2-S6	51"	\$1,309
48"	A6054C-S6	A6054B-S6	A6054W1-S6	A6054W2-S6	A6054K1-S6	A6054K2-S6	54"	\$1,344
51"	A6057C-S6	A6057B-S6	A6057W1-S6	A6057W2-S6	A6057K1-S6	A6057K2-S6	57"	\$1,378
54"	A6060C-S6	A6060B-S6	A6060W1-S6	A6060W2-S6	A6060K1-S6	A6060K2-S6	60"	\$1,411
57"	A6063C-S6	A6063B-S6	A6063W1-S6	A6063W2-S6	A6063K1-S6	A6063K2-S6	63"	\$1,446
60"	A6066C-S6	A6066B-S6	A6066W1-S6	A6066W2-S6	A6066K1-S6	A6066K2-S6	66"	\$1,480

A60 Graduated Knob Models

Travel Inches	40 turns inch	20 turns inch	10 turns inch	5 turns inch	10 turns cm.	5 turns cm.	Base Length	Price
3"	A6009P40-S6	A6009P20-S6	A6009P10-S6	A6009P5-S6	A6009Q1-S6	A6009Q2-S6	9"	\$652
6"	A6012P40-S6	A6012P20-S6	A6012P10-S6	A6012P5-S6	A6012Q1-S6	A6012Q2-S6	12"	\$694
9"	A6015P40-S6	A6015P20-S6	A6015P10-S6	A6015P5-S6	A6015Q1-S6	A6015Q2-S6	15"	\$737
12"	A6018P40-S6	A6018P20-S6	A6018P10-S6	A6018P5-S6	A6018Q1-S6	A6018Q2-S6	18"	\$783
15"	A6021P40-S6	A6021P20-S6	A6021P10-S6	A6021P5-S6	A6021Q1-S6	A6021Q2-S6	21"	\$821
18"	A6024P40-S6	A6024P20-S6	A6024P10-S6	A6024P5-S6	A6024Q1-S6	A6024Q2-S6	24"	\$869

A60 Screw Drive with Scale and Vernier Models

Travel Inches	40 turns inch	20 turns inch	10 turns inch	5 turns inch	10 turns cm.	5 turns cm.	Base Length	Price
3"	A6009CE-S6	A6009BE-S6	A6009WE-S6	A6009W2E-S6	A6009K1M-S6	A6009K2M-S6	9"	\$600
6"	A6012CE-S6	A6012BE-S6	A6012WE-S6	A6012W2E-S6	A6012K1M-S6	A6012K2M-S6	12"	\$654
9"	A6015CE-S6	A6015BE-S6	A6015WE-S6	A6015W2E-S6	A6015K1M-S6	A6015K2M-S6	15"	\$709
12"	A6018CE-S6	A6018BE-S6	A6018WE-S6	A6018W2E-S6	A6018K1M-S6	A6018K2M-S6	18"	\$771
15"	A6021CE-S6	A6021BE-S6	A6021WE-S6	A6021W2E-S6	A6021K1M-S6	A6021K2M-S6	21"	\$828

A60 Full Travel, Unlimited Fine Adjust Model H and HE/HM

Travel Inches	Rapid Advance			Rapid Advance with Scale and Vernier			Base Length
	Model H20	Model H1	Price	Model HE	Model HM	Price	
3"	A6009H20-S6	A6009H1-S6	\$672	A6009HE-S6	A6009HM-S6	\$788	9"
6"	A6012H20-S6	A6012H1-S6	\$719	A6012HE-S6	A6012HM-S6	\$840	12"
9"	A6015H20-S6	A6015H1-S6	\$772	A6015HE-S6	A6015HM-S6	\$894	15"
12"	A6018H20-S6	A6018H1-S6	\$830	A6018HE-S6	A6018HM-S6	\$954	18"
15"	A6021H20-S6	A6021H1-S6	\$863				
18"	A6024H20-S6	A6024H1-S6	\$895				
21"	A6027H20-S6	A6027H1-S6	\$962				
24"	A6030H20-S6	A6030H1-S6	\$1,038				
27"	A6033H20-S6	A6033H1-S6	\$1,119				
30"	A6036H20-S6	A6036H1-S6	\$1,202				

**For Options
see page 7**

Download our current
Catalog

Product Weight

Series B90 with standard 9" long slider

Read down for travel, across for desired lead screw and price. Call Velmex for longer units.



B90 Free Sliding Models

Travel Inches	Catalog Number	Base Length	Price
3"	B9012A-S9	12"	\$539
6"	B9015A-S9	15"	\$594
9"	B9018A-S9	18"	\$656
12"	B9021A-S9	21"	\$726
15"	B9024A-S9	24"	\$789
18"	B9027A-S9	27"	\$874
21"	B9030A-S9	30"	\$966
24"	B9033A-S9	33"	\$1,068
27"	B9036A-S9	36"	\$1,179
30"	B9039A-S9	39"	\$1,303
33"	B9042A-S9	42"	\$1,441
36"	B9045A-S9	45"	\$1,593
39"	B9048A-S9	48"	\$1,761
42"	B9051A-S9	51"	\$1,793
45"	B9054A-S9	54"	\$1,825
48"	B9057A-S9	57"	\$1,857
51"	B9060A-S9	60"	\$1,890
54"	B9063A-S9	63"	\$1,922
57"	B9066A-S9	66"	\$1,954
60"	B9069A-S9	69"	\$1,986
63"	B9072A-S9	72"	\$2,018
66"	B9075A-S9	75"	\$2,050
69"	B9078A-S9	78"	\$2,082
72"	B9081A-S9	81"	\$2,114
75"	B9084A-S9	84"	\$2,147

**For Options
see page 7**

Download our current
Catalog

Product Weight

B90 Screw Drive Models

Travel Inches	Lead Screw Pitch						Base Length	Price
	40 turns inch	20 turns inch	10 turns inch	5 turns inch	10 turns cm.	5 turns cm.		
3"	B9012C-S9	B9012B-S9	B9012W1-S9	B9012W2-S9	B9012K1-S9	B9012K2-S9	12"	\$737
6"	B9015C-S9	B9015B-S9	B9015W1-S9	B9015W2-S9	B9015K1-S9	B9015K2-S9	15"	\$806
9"	B9018C-S9	B9018B-S9	B9018W1-S9	B9018W2-S9	B9018K1-S9	B9018K2-S9	18"	\$880
12"	B9021C-S9	B9021B-S9	B9021W1-S9	B9021W2-S9	B9021K1-S9	B9021K2-S9	21"	\$959
15"	B9024C-S9	B9024B-S9	B9024W1-S9	B9024W2-S9	B9024K1-S9	B9024K2-S9	24"	\$1,031
18"	B9027C-S9	B9027B-S9	B9027W1-S9	B9027W2-S9	B9027K1-S9	B9027K2-S9	27"	\$1,127
21"	B9030C-S9	B9030B-S9	B9030W1-S9	B9030W2-S9	B9030K1-S9	B9030K2-S9	30"	\$1,230
24"	B9033C-S9	B9033B-S9	B9033W1-S9	B9033W2-S9	B9033K1-S9	B9033K2-S9	33"	\$1,345
27"	B9036C-S9	B9036B-S9	B9036W1-S9	B9036W2-S9	B9036K1-S9	B9036K2-S9	36"	\$1,467
30"	B9039C-S9	B9039B-S9	B9039W1-S9	B9039W2-S9	B9039K1-S9	B9039K2-S9	39"	\$1,603
33"	B9042C-S9	B9042B-S9	B9042W1-S9	B9042W2-S9	B9042K1-S9	B9042K2-S9	42"	\$1,750
36"	B9045C-S9	B9045B-S9	B9045W1-S9	B9045W2-S9	B9045K1-S9	B9045K2-S9	45"	\$1,909
39"	B9048C-S9	B9048B-S9	B9048W1-S9	B9048W2-S9	B9048K1-S9	B9048K2-S9	48"	\$2,085
42"	B9051C-S9	B9051B-S9	B9051W1-S9	B9051W2-S9	B9051K1-S9	B9051K2-S9	51"	\$2,123
45"	B9054C-S9	B9054B-S9	B9054W1-S9	B9054W2-S9	B9054K1-S9	B9054K2-S9	54"	\$2,160
48"	B9057C-S9	B9057B-S9	B9057W1-S9	B9057W2-S9	B9057K1-S9	B9057K2-S9	57"	\$2,199
51"	B9060C-S9	B9060B-S9	B9060W1-S9	B9060W2-S9	B9060K1-S9	B9060K2-S9	60"	\$2,236
54"	B9063C-S9	B9063B-S9	B9063W1-S9	B9063W2-S9	B9063K1-S9	B9063K2-S9	63"	\$2,273
57"	B9066C-S9	B9066B-S9	B9066W1-S9	B9066W2-S9	B9066K1-S9	B9066K2-S9	66"	\$2,311
60"	B9069C-S9	B9069B-S9	B9069W1-S9	B9069W2-S9	B9069K1-S9	B9069K2-S9	69"	\$2,348
72"	B9072C-S9	B9072B-S9	B9072W1-S9	B9072W2-S9	B9072K1-S9	B9072K2-S9	72"	\$2,386
66"	B9075C-S9	B9075B-S9	B9075W1-S9	B9075W2-S9	B9075K1-S9	B9075K2-S9	75"	\$2,423
69"	B9078C-S9	B9078B-S9	B9078W1-S9	B9078W2-S9	B9078K1-S9	B9078K2-S9	78"	\$2,461
72"	B9081C-S9	B9081B-S9	B9081W1-S9	B9081W2-S9	B9081K1-S9	B9081K2-S9	81"	\$2,498
75"	B9084C-S9	B9084B-S9	B9084W1-S9	B9084W2-S9	B9084K1-S9	B9084K2-S9	84"	\$2,537











B90 Graduated Knob Model s

Travel Inches	Lead Screw Pitch						Base Length	Price
	40 turns inch	20 turns inch	10 turns inch	5 turns inch	10 turns cm.	5 turns cm.		
3"	B9012P40-S9	B9012P20-S9	B9012P10-S9	B9012P5-S9	B9012Q1-S9	B9012Q2-S9	12"	\$977
6"	B9015P40-S9	B9015P20-S9	B9015P10-S9	B9015P5-S9	B9015Q1-S9	B9015Q2-S9	15"	\$1,060
9"	B9018P40-S9	B9018P20-S9	B9018P10-S9	B9018P5-S9	B9018Q1-S9	B9018Q2-S9	18"	\$1,156
12"	B9021P40-S9	B9021P20-S9	B9021P10-S9	B9021P5-S9	B9021Q1-S9	B9021Q2-S9	21"	\$1,242
15"	B9024P40-S9	B9024P20-S9	B9024P10-S9	B9024P5-S9	B9024Q1-S9	B9024Q2-S9	24"	\$1,345
18"	B9027P40-S9	B9027P20-S9	B9027P10-S9	B9027P5-S9	B9027Q1-S9	B9027Q2-S9	27"	\$1,454



Call Velmex for prices of longer UniSlide Assemblies

Options								Option is available in these Models					
Clicking on photos with BLUE border will take you to the relevant web page.	Specified by Letter	Series					Free Travel	Screw Drive	Graduated Knob	Scale and Vernier	Rapid Advance	Left/Right Screw	
		A15	A25	A40	A60	B90							
	Longer slider lengths	S2 \$18	S3 \$26	S6 \$35	S8 \$38	S12 \$49	●	●	●	●	●	●	
		S3 \$31	S4 \$33				●	●	●	●	●	●	
	Deeper "B" base	B-	NA	\$3/in	\$4/in	\$5/in	NA	●	●	●	●	●	
	Optional Finish (Price maybe subject to a minimum lot charge)												
	Hard Anodized Base, dyed black	Z-	\$43	\$48	\$54	\$64	\$80	●	●	●			
	Electroless Nickel	N-	\$43	\$48	\$54	\$64	\$80	●	●	●			
	Black Anodize	-BK	\$27	\$32	\$37	\$43	\$54	●	●	●	●	●	
	Locks												
	Thumbscrew-on-leadscrew lock	-TL							●	●	●	●	
	Slider lock, Right side	-SLR	\$33	\$35	\$37	\$43	\$45	●	●	●	●	●	
	Slider lock, Left side	-SLL						●	●	●	●	●	
	Traveling Slider Lock (available only in standard slider length)	-TSL	\$45	\$49	\$54	\$58	\$79	●	●	●	●	●	
	Revolution Counter	-RC	\$89	\$89	\$89	\$89	\$89		●	●	●	●	
	Waycovers	-WC	NA	\$114	\$140	\$156	\$224		●	●		●	
	plus, add per inch of free travel			\$6/in	\$9/in	\$9/in	\$9/in						

Page* Model.....Price

Enhanced straightness tolerance

1.37 \$7/in.

Right angle gear box

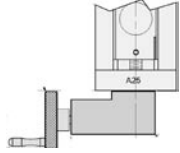

1.35 5005B-A3-U or D
or R or L.....\$333

Assembled X-Y tables



1.39 AXY2506W1.....\$1,213
AXY2509W1.....\$1,314
AXY2512W1.....\$1,472
BK.....\$152
Z.....\$214
WA.....\$146

AXY4006W1.....\$799
AXY4009W1.....\$863
BK.....\$109
Z.....\$216
Graduated Model.....\$219

AXY6009W1.....\$1,156
AXY6012W1.....\$1,140
AXY6015W1.....\$1,322
BK.....\$109
Z.....\$216
Graduated Model.....\$285

Elevating Tables



1.42 B2904W1.....\$396
B2906W1.....\$408
B2909W1.....\$431
TL.....\$34
BK.....\$62
Graduated Model.....\$111

B4906W1.....\$499
B4909W1.....\$551
B4912W1.....\$608
TL.....\$34
BK.....\$75
Graduated Model.....\$111

Page* ModelPrice

B6909W1.....\$753
B6912W1.....\$829
B6915W1.....\$904
TL.....\$34
BK.....\$75
Graduated Model.....\$144

A3901W1.....\$335
A3903W1.....\$384
BK.....\$50
DL.....\$34

X-Y Adapters

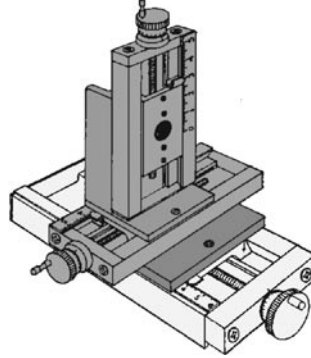

1.44 A1500XY.....\$29
A2500XY.....\$32
A4000XY.....\$38
A6000XY.....\$57
B9000XY.....\$84
BK..... add 10%

XZ Adapters

1.46 A1500XZ.....\$23
A2500XZ.....\$33
A2501XZ.....\$94
B2503XZ.....\$115

A4000XZ.....\$38
A4001XZ.....\$122
B4003XZ.....\$157
B4004XZ.....\$184
A6000XZ.....\$61
A6001XZ.....\$141
B6003XZ.....\$172
B6004XZ.....\$197

B9000XZ.....\$89
B9001XZ.....\$257
B9002XZ.....\$297
B9003XZ.....\$344
BK..... add 10%

Rotary Encoder

1.53 3-919-E.....\$250
3-919-QCable.....\$46
3-918E replacement only.....\$190

Page* Model.....Price

TA Rapid Advance



1.52 TA4009H1-S6.....\$643
TA4012H1-S6.....\$685
TA4015H1-S6.....\$734
TA4018H1-S6.....\$782
TA4021H1-S6.....\$835
TA4024H1-S6.....\$888
TA4027H1-S6.....\$946
TA4030H1-S6.....\$998

TA system options

1.52 TAB2.....\$64
TAC-PC.....\$48
TAC-MAC.....\$54

Quick-Chek DRO

1.52 QC-10V.....\$648
QC-120-AR.....\$1,065
QC-130-AR.....\$1,480

ACU-RITE linear encoders

5 um resolution
585275-02.....\$602
585275-04.....\$606
585275-06.....\$627
585275-08.....\$632
585275-10.....\$643
585275-12.....\$643
585275-13.....\$643
585275-14.....\$679
585275-16.....\$699
585275-18.....\$730
585275-20.....\$746
585275-24.....\$782

1um resolution

585271-02.....\$908
585271-04.....\$908
585271-06.....\$935
585271-08.....\$935
585271-10.....\$948
585271-12.....\$948
585271-13.....\$948
585271-14.....\$964
585271-16.....\$995
585271-18.....\$1,097
585271-20.....\$1,179
585271-24.....\$1,230

**For Options
see page 7**

*Page refers to the product page in Catalog C06

Manual BiSlide® with knob and thumb lock page 1.59



Travel		Leadscrew pitch				Weight		
in	cm	0.100"/turn	0.400"/turn	1 mm/turn	2 mm/turn	Price	lbs.	kg.
5	12.7	MN10-0050-E01-11	MN10-0050-E04-11	MN10-0050-M01-11	MN10-0050-M02-11	\$748	6.9	3.2
10	25.4	MN10-0100-E01-11	MN10-0100-E04-11	MN10-0100-M01-11	MN10-0100-M02-11	\$795	8.7	4
15	38.1	MN10-0150-E01-11	MN10-0150-E04-11	MN10-0150-M01-11	MN10-0150-M02-11	\$827	10.5	4
20	50.8	MN10-0200-E01-11	MN10-0200-E04-11	MN10-0200-M01-11	MN10-0200-M02-11	\$873	12.2	5.5
30	76.2	MN10-0300-E01-11	MN10-0300-E04-11	MN10-0300-M01-11	MN10-0300-M02-11	\$982	15.7	7.1
40	101.6	MN10-0400-E01-11	MN10-0400-E04-11	MN10-0400-M01-11	MN10-0400-M02-11	\$1,233	20.3	9.2
50	127	MN10-0500-E01-11	MN10-0500-E04-11	MN10-0500-M01-11	MN10-0500-M02-11	\$1,374	23.8	10.8
60	152.4	MN10-0600-E01-11	MN10-0600-E04-11	MN10-0600-M01-11	MN10-0600-M02-11	\$1,528	27.3	12.4
80	203.2	MN10-0800-E01-11	MN10-0800-E04-11	MN10-0800-M01-11	MN10-0800-M02-11	\$1,883	34.3	15.6

See *Motorized Products Price List* for BiSlide mounting hardware etc.

Manual BiSlide® with knob, counter and thumb lock page 1.59



Insert your choice in place

BiSlide orientation vertical: 13 counter increments + from knob, 15 counter increments - from knob

Travel		Leadscrew pitch				Weight		
in	cm	0.100"/turn	0.400"/turn	1 mm/turn	2 mm/turn	Price	lbs.	kg.
5	12.7	MN10-0050-E01-yy	MN10-0050-E04-yy	MN10-0050-M01-yy	MN10-0050-M02-yy	\$832	7.4	3.4
10	25.4	MN10-0100-E01-yy	MN10-0100-E04-yy	MN10-0100-M01-yy	MN10-0100-M02-yy	\$878	9.2	4.2
15	38.1	MN10-0150-E01-yy	MN10-0150-E04-yy	MN10-0150-M01-yy	MN10-0150-M02-yy	\$910	11.0	5.0
20	50.8	MN10-0200-E01-yy	MN10-0200-E04-yy	MN10-0200-M01-yy	MN10-0200-M02-yy	\$956	12.7	5.8
30	76.2	MN10-0300-E01-yy	MN10-0300-E04-yy	MN10-0300-M01-yy	MN10-0300-M02-yy	\$1,065	16.2	7.4
40	101.6	MN10-0400-E01-yy	MN10-0400-E04-yy	MN10-0400-M01-yy	MN10-0400-M02-yy	\$1,317	20.8	9.4
50	127	MN10-0500-E01-yy	MN10-0500-E04-yy	MN10-0500-M01-yy	MN10-0500-M02-yy	\$1,457	24.3	11.0
60	152.4	MN10-0600-E01-yy	MN10-0600-E04-yy	MN10-0600-M01-yy	MN10-0600-M02-yy	\$1,611	27.8	12.6
80	203.2	MN10-0800-E01-yy	MN10-0800-E04-yy	MN10-0800-M01-yy	MN10-0800-M02-yy	\$1,967	34.8	15.8

See *Motorized Products Price List* for BiSlide mounting hardware etc.

Parallel Coupled BiSlide

PC1-xxx (xxx is inch C to C) Manual Coupled (Belt, Pulleys, Cover, Brgs, Knob)*\$785.00+\$5.00 / inch

*Price does not include installation of belt and crating charge. Assembly instructions and Belt Tensioner are included.

Call for pricing of Side Control Knob BiSlide Assemblies.

Rotary Tables page 1.62

	Model Number	Price
	A4872TS	\$1,308
	A4836TS	\$1,308
	A4818TS	\$1,308
As above but Black	-BK	\$109
Thumbscrew Lock	-TL	\$38
Adapter Plate	A6000TX	\$39
	A5990TS-BK	\$864
	-TL	\$36
Adapter Plate	B5900TXZ-BK	\$45

Turntables page 1.64

A2505TS \$306



A4007TS \$348

