

# Operation Manual

## SERIES *EMIX23*

Magnetic Length Measuring System with 0,001 resolution

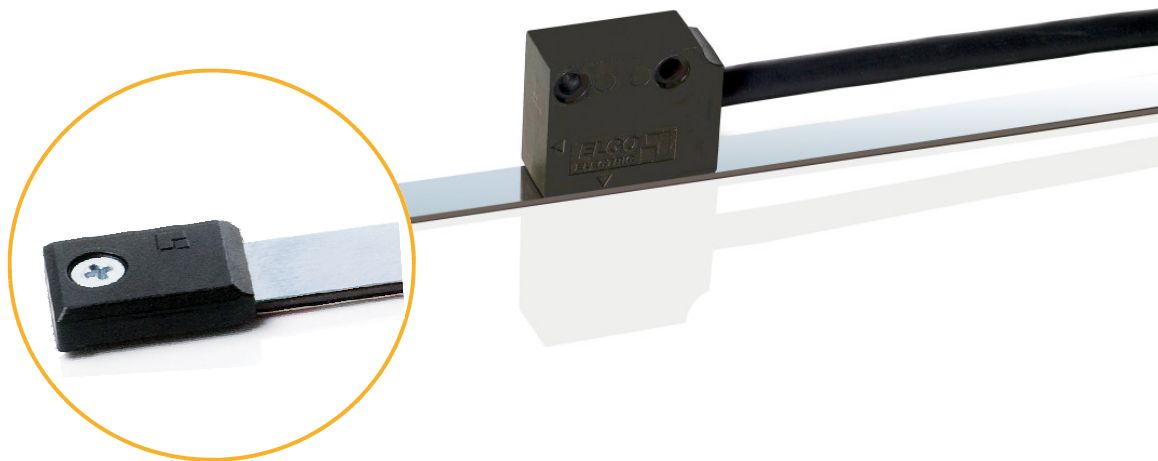

- With periodic index pulse
- Differential 5 V-TTL line driver or 10... 30 V-HTL outputs
- Various resolutions available (order designation)
- Repeat accuracy +/- 1 increment
- Small sensor with integrated translator
- Speed proportional output of the square waves

1	General.....	3
1.1	Information Operation Manual .....	3
1.2	Explanation of Symbols .....	3
1.3	Statement of Warranties.....	4
1.4	Demounting and Disposal.....	4
2	Safety .....	5
2.1	General Cause of Risks.....	5
2.2	Personal Protective Equipment.....	5
2.3	Conventional Use .....	6
3	Transport and Storage .....	7
3.1	Safety instructions for transport, unpacking and loading .....	7
3.2	Handling of Packaging Material .....	7
3.3	Check of Transport .....	7
3.4	Storage .....	7
4	Product features.....	8
5	Technical Data .....	9
5.1	Technical Data EMIX23 .....	9
5.2	Dimensions EMIX23 .....	10
5.3	Installation Possibilities EMIX23 .....	10
6	Installation and Initial Start-up.....	11
6.1	Operational Environment .....	11
6.2	Interferences .....	12
6.3	Installation Sensor head .....	13
6.4	Pin Assignment EMIX23.....	13
6.4.1	.....	13
7	Options .....	14
7.1	Magnetic Tape MB20-20-10-1-R.....	14
7.1.1	Components .....	14
7.1.2	Handling .....	15
7.1.3	Technical Data Magnetic Tape .....	15
7.1.4	Processing hint for the sticking of magnetic tapes .....	16
7.1.5	Chemical resistance of the magnetic tape .....	16
8	Interferences.....	17
8.1	Safety.....	17
8.2	Restarting after fault Clearance .....	17
9	Maintenance .....	18
10	Cleaning.....	18
11	Type Designation .....	19
12	Index .....	20
13	Document History.....	20

# 1 General

## 1.1 Information Operation Manual

The manual contains important information regarding the handling of the indicator.

For Your own safety please note all safety warnings and instructions.

Precondition for safe operation is the compliance with the specified safety and handling instructions. Moreover, observe the existing local accident prevention regulation and general safety rules.

Please read the operation manual carefully before starting to work. The manual should be kept accessible at anytime. The illustrations in the manual are for better representation of the facts they are not necessarily to scale and can be slightly different to the actual construction.

## 1.2 Explanation of Symbols

Warning notices are characterised by symbols in the operation manual.

The notes will be introduced by signal words to express the magnitude of the danger.

Follow these advices in order to avoid accidents and injuries to persons and property.

### Warning notices:

	<b>DANGER!</b> ... adverts to direct dangerous situations that can lead to death or severe injuries.
	<b>CAUTION!</b> ... advices to potentially dangerous situations that can lead to death or severe injuries.
	<b>ATTENTION!</b> ... advices to potentially dangerous situations that can lead to damages on property.
	<b>ADVERT!</b> ...highlights helpful hints and recommendations for efficient and failure-free operation.

### Specific safety instructions:

	<b>DANGER!</b> ...marks perilous situations by electricity. By non-observance of the safety instructions the possibilities of death or severe injuries exist. The operations have to be carried out only by an electrician.
---	--

### Tips and recommendations:

	<b>Note!</b> Here you can see Highlights, useful tips, information and recommendations for efficient and trouble-free operation.
---	---

### 1.3 Statement of Warranties

The warranty conditions are in a separate document.

#### Guarantee

The producer guarantees the functional capability of the process engineering and the selected parameter. The period of warranty is one year and begins with the date of delivery.

### 1.4 Demounting and Disposal

Unless otherwise authorized, dispose the item considering the safety instructions.

#### Before demounting

- Disconnect the power supply
- Secure against re-start
- Disconnect supply lines physically and discharge remaining energy
- Dispose operating supplies with respect to the environment

#### Disposal

Recycle the decomposed elements:

- Scrap metal elements
- Electronic components in electronic scrap
- Recycle plastic parts
- Dispose the rest of the components according to their material consistence



#### ATTENTION!

Wrong disposal → damage caused to the environment!

Electronic waste, electronic components, lubricants and operating supplies are liable to treatment of hazardous waste.

Only approved specialized companies should perform disposal.



Local authorities and waste management facilities provide information about environmentally suitable disposal.

## 2 Safety

	<p><b>ADVERT</b> Please read the operation manual carefully, before using the device! Observe the Installation instructions! In case of damage caused by failure of these operating instructions the warranty expires.</p> <p>ELGO Electronic GmbH &amp; Co. KG and its subsidiaries are not liable for any damage at persons, property or asset caused by defective material on the device and / or its associated. We take no responsibility for consequential damage!</p> <p>The operator is obliged to appropriate security-related measures and implement.</p> <p>The Commissioning may only be performed by qualified and by the operator authorized and trained personnel.</p>
---	---

### 2.1 General Cause of Risks

This chapter gives an overview about all important safety aspects to guarantee an optimal protection of employees. (See at chapter 9)

Non-observance of the instructions mentioned in this operation manual can result in hazardous situations.



### 2.2 Personal Protective Equipment

Employees should wear protective clothing during installation of the device to minimize the risk of accidents.

Therefore:

Change into protective clothing before beginning the work process. Also observe any labels in the operating area regarding protective clothing.

**Protective clothing:**

	<p><b>Safety working clothing</b> ... is close-fitting ... is tear proof ... has tight sleeves without distant parts</p> <p><b>Also wear no rings, necklaces or other jewellery.</b></p>
	<p><b>Protective gloves</b> ... for protecting the hands against abrasion and cuts.</p>

## 2.3 Conventional Use

The Length Measuring System **EMIX23** is for the limited purpose as described in this manual:

The EMIX23 length measuring system is only constructed for measuring distances.



### CAUTION!

Danger through non-conventional use!  
Non-intended use and non-observance of this operation manual can lead to dangerous situations.

Therefore:

- Use **EMIX23** only as described
- Strictly follow this manual

Avoid in particular:

Remodelling, refitting or changing of the device or parts of it with the intention to alter functionality or scope of the position indicator.

ELGO is not liable for any damages resulting from improper use of the product.  
The Operator is liable for all damages during non-conventional use.

### 3 Transport and Storage

#### 3.1 Safety instructions for transport, unpacking and loading

**ATTENTION!**

Professional transport only.  
Do not throw, hit or fold the package.

#### 3.2 Handling of Packaging Material

Adverts for proper disposal refer to 1.4 .

#### 3.3 Check of Transport

Examine delivery immediately after receiving for completeness and transport damages.

In case of externally recognizable transport damages:

- Do not accept the delivery or do accept under reserve
- Note extent of damages on the transportation documents or on the delivery note
- File complaint immediately

**ADVERT!**

Claim any damages you recognize as soon as possible. The claims for damage must be filed in the lawful reclaim periods.

#### 3.4 Storage

Store device only under following conditions:

- Do not store outside
- Keep dry and dust-free
- Do not expose to aggressive media
- Protect from direct sun light
- Avoid mechanical shocks
- Storage temperature: 20 to + 50 °C
- Relative humidity: 60% non-condensing
- Inspect packages regularly if stored for an extensive period of time (> 3 months)

## 4 Product features

**General:** Based on the proven *EMIX2* linear encoder system, the high resolution linear encoder *EMIX23* was developed and offers two considerable advantages:

*EMIX23* is available in many different resolutions. In spite of its small dimensions, the translator is integrated in the sensor head. The installation of the sensor can also be done vertically. This must be mentioned when ordering. (Option L). Integrated in the sensor head are the magneto resistive measuring-bridges as well as the interpolation circuit and the output drivers. The bridge generates the distance depending count pulses for the signal processing electronic. The gap between sensor and tape must not be larger than 0,8 mm. Each smaller value (0.1 – 0,8 mm) is permitted. The sensor cable is an eight wire cable, highly flexible and suitable for tug chains. It consists of twisted pair wires and is shielded.

### Product features:

- Speed-proportional square wave outputs
- Wear free measuring principle
- Contactless scanning of position
- Allowed distance sensor/tape: up to 0.8 mm
- Differential 5 V-TTL or 10... 30 V-HTL output logic
- With index-pulse
- Resolution = 0,001 mm (at four edge triggering)
- Repeating accuracy +/- 0,001 mm
- Sensor with integrated translator

### Possible Resolutions:

Interpolation Rate	Resolution at IW4 [ $\mu\text{m}$ ]	(Type-) Designation
8192*	0,244140625	N244*
4096*	0,48828125	N488*
2048*	0,9765625	N976*
2000	1	0001
1600	1,25	1N25
1024	1,953125	1N95
1000	2	0002
800	2,5	2N50
512	3,90625	3N90
500	4	0004
400	5	0005
320	6,25	6N25
256	7,8125	7N81
250	8	0008
200	10	0010
160	12,5	12N5
128	15,625	15N6
125	16	0016
100	20	0020
80	25	0025
64	31,25	31N2
50	40	0040
40	50	0050
32	62,5	62N5
25	80	0080
16	125	0125
8	250	0250
4	500	0500



## 5 Technical Data

### 5.1 Technical Data EMIX23

#### **Length Measuring System EMIX23-000**

Power Supply	10... 30 VDC / 5VDC
Consumption	10.. 30 VDC: max. 150mA / 5 VDC: 200 mA
Signal	10... 30 V HTL / 5V TTL
Resolution	0,001 mm
repeat Accuracy	+/- 0,001 mm
Max. Drive Speed	2 m/s
Output Signals	A, A', B, B', Z, Z'
measuring Length	theoretical unlimited
Distance Sensor/Tape	max. 0,8 mm
System accuracy in $\mu\text{m}$ at 20°C	+/- (20 + 20 x L) L= Measuring length in Meter)
Operation Temperature	-10°... +70°C (-25°... +85 °C)
Store Temperature	-25°... +85°C
Humidity	not condensing, max. 80%
Protection Class	IP67
Mechanical Data Sensor	EMIX23-Housing: 30 x 12,5 x 25 mm
Cable	drag chain able, Length max. 30,0 m, Weight: ca. 58,0 g/m, Wires: 2 x 0,75 mm <sup>2</sup> und 6 x 0,14 mm <sup>2</sup> bending Radius: min. 60 mm

#### **Magnetic Tape MB20.20**

Magnetic Tape MB20-20-10-1-R	Coefficient of Expansion @ = $16 \times 10^{-6} \text{K}^{-1}$ Linear Expansion $\Delta L = L \times @ \times \Delta @$ 10mm x ca. 1,8mm (B x H) min. bending Radius 150mm
------------------------------	---

## 5.2 Dimensions EMIX23

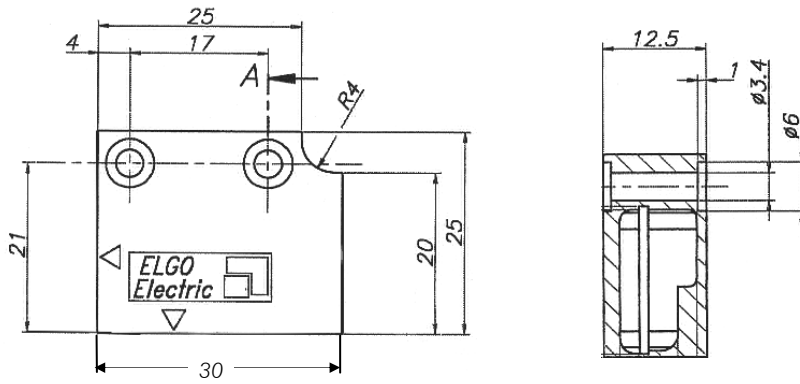

## 5.3 Installation Possibilities EMIX23

**Standard** (horizontal)

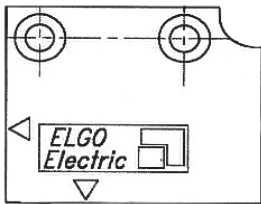

**Option L** (vertical)  
(must be indicated in case of an order)

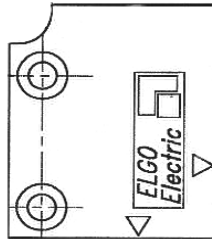





## 6 Installation and Initial Start-up

	<p><b>ADVERT</b></p> <p>Please read the operating instructions carefully before using this device! Installation instructions must be observed! In case of damage caused by failure observing the installation instructions, the warranty will be invalidated.</p> <p>The ELGO Electronic GmbH &amp; Co. KG and the subsidiaries are not liable for injury to persons, property or financial loss, which can be caused by faulty material on the device and / or incurred by the related components. We assume no liability for damages!</p> <p>The operator is obliged to take appropriate security measures and implement them.</p> <p>The commissioning should only be performed by qualified and authorized personnel.</p>
---	---

### 6.1 Operational Environment

	<p><b>WARNING!</b></p> <p>Do not use the device in explosive or corrosive environments!</p>
---	---

	<p><b>CAUTION!</b></p> <p>The electrical connections are made by suitably qualified personnel in accordance with local regulations.</p>
	<p>The device is designed for switchboard mounting. During the work on the switchboard, all components must be free of tension if the danger exists, that energized parts can be touched. (Finger protection)</p>
	<p>Wiring may only be energized!</p> <p>Thin wire cable strands are equipped with ferrule!</p> <p>Before switching on all ports and connectors are to be reviewed!</p>
	<p>The device must be mounted that it is protected against harmful environmental influences such as splashing water, solvent, vibration, shock and severe pollution and also the operating temperature is to be maintained..</p>

## 6.2 Interferences

If errors cannot be corrected with the following instructions please contact the manufacturer (see last page).



### NOTE

Device, connection cables and signal cables must not be installed directly next to interference, which have strong inductive or capacitive interference or strong electrostatic fields!

External interference can be avoided by a suitable cable routing.



Signal wires and cables are principally laid separately from the LASTSTROMLEITUNG and keep a safety distance of at least 0,5m to inductive or capacitive interference sources such as contactors, relays, motors, switching power supplies, clocked controllers, etc.!

If faults occur despite of compliance of all the described items above, it must proceed as follows:

1. Attachment of RC elements of contactor coils of AC contactors (e.g.  $0.1 \mu\text{F} / 100\Omega$ )
2. Attachment of free-wheeling diodes using DC inductors
3. Attachment of RC elements of individual motor phases (in the terminal box of the engine)
4. Do not connect safety ground and reference potential
5. Pre-connecting a mains filter on the external power supply
6. Use of sheet metal or metalized shielding housings

### 6.3 Installation Sensor head

For the Mounting of the Sensor head, please use two M3 screws.  
It is necessary to keep the tolerances for Distance and angle.

Parallel Adjustment:

Mid of Sensor =  
Mid of tape (+/- 0,5 mm)

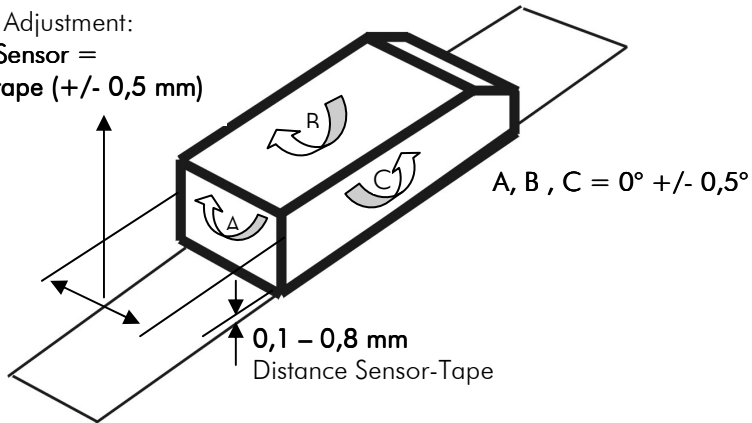

### 6.4 Pin Assignment EMIX23

	Cable end open Standard 6.4.1	D-SUB 9 pins Option D1 (Elgo- D-SUB standard)
Function	Colour	Pin no.
0V (GND)	White	1
5VDC/10-30 VDC in	Brown	2
Channel A	Green	3
Channel B	Yellow	4
Channel Z	Black	8
Channel A'	Violet	6
Channel B'	Orange	7
Channel Z'	Gray	9
screen	PE	Connected to housing

D-SUB connector  
**Option D1** (solder side)

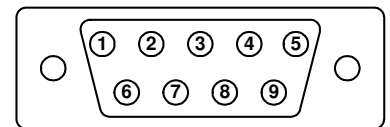

## 7 Options

### 7.1 Magnetic Tape MB20-20-10-1-R

The magnetic tape contains the necessary digital information needed for linear length measurement using an ELGO length measuring systems. Basically a distinction is made between incremental and absolute measuring. The incremental measuring system consists of reading electronic, which is scanning north and south poles on the magnetic tape and is creating a Sine and Cosine signal.

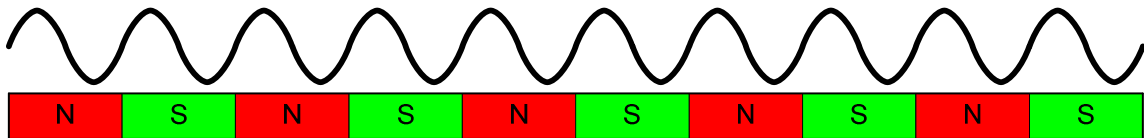

These signals are electronically interpolated, the resolution of the measuring system results of the interpolation rate and the pole length.

#### 7.1.1 Components

In the standard case, the magnetic tape is delivered as described. It is installed by gluing it to the respective mounting surface.

The magnetic tape consists of 2 pre-assembled components (see Figure 1):

- A magnetized, flexible plastic tape (Pos. 3), which is connected with a magnetically conductive steel tape as inference band (Pos. 4) and is supplied with an adhesive tape (Pos. 5).
- A magnetized permeable cover tape (Pos. 1), which serves for the mechanical protection of the plastic tape (not required for the measurement) and is supplied with an adhesive tape (Pos. 2).

Therefore a divergent tape structure and scope of delivery is also possible. The cover tape is also available separately.

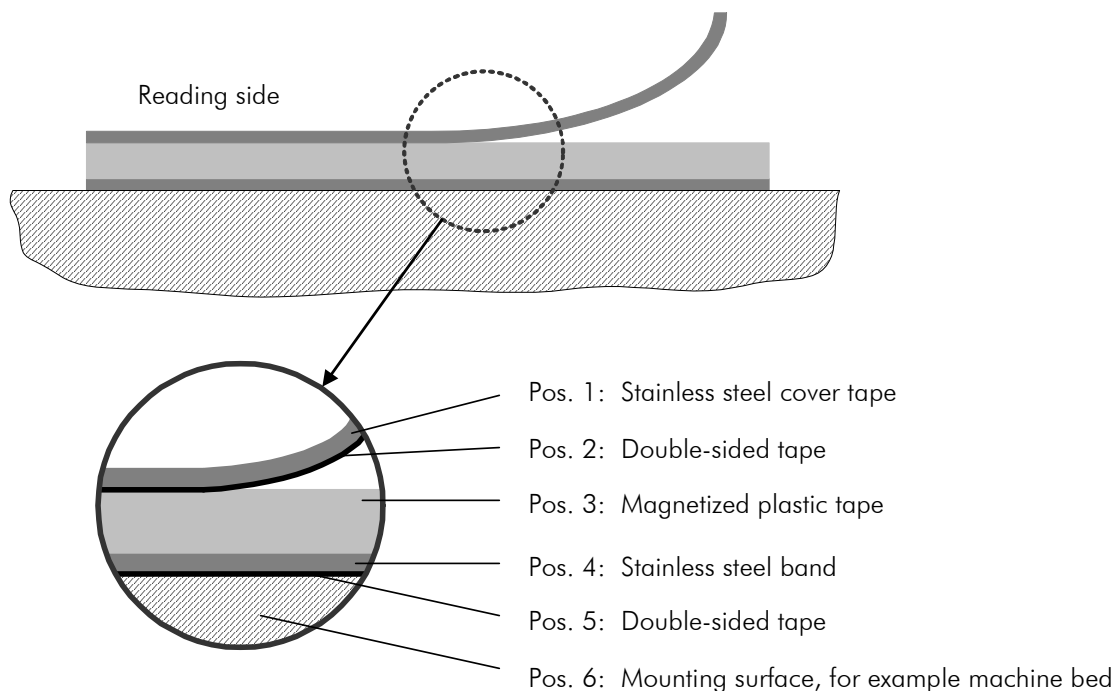

Figure 1: Components of the magnetic tape

### 7.1.2 Handling

In order to avoid tension in the tape, it must not be stretched, compressed or twisted. It should be stored with the magnetized plastic tape to the outside (see Figure 2), the minimum bending radius must be noted here (see section 7.1.3).

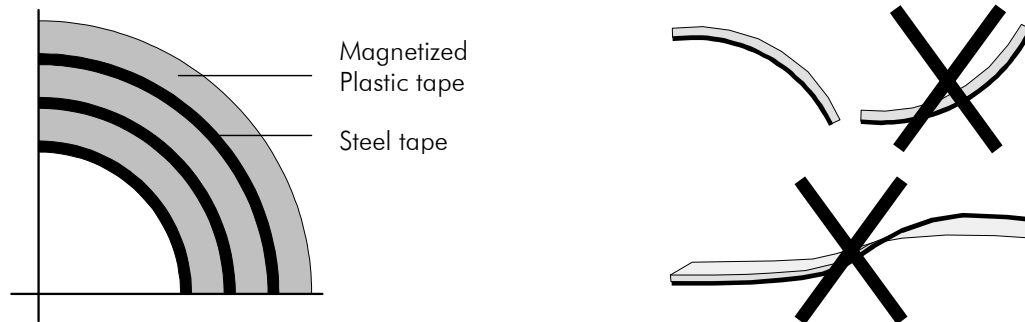

Figure 2: Handling

### 7.1.3 Technical Data Magnetic Tape

<b>Magnetic tape MB20.20</b>	
Coding	Incremental, single track
Pole length	2 mm
Operating temperature	0 °C ... +50 °C
Storage temperature	Short term: -10 °C ... +60 °C Medium term: 0 °C ... +40 °C Long term: +18 °C
Relative humidity	max. 95 %, non-condensing
Accuracy at 20°C in mm	+/- (0.025 + 0.02 x L[m]) (L = measuring length in meter)
Thermal expansion	$\Delta L[m] = L[m] \times \alpha[1/K] \times \Delta\vartheta[K]$ (L = tape length in meter, $\Delta\vartheta$ = relative temperature change)
Linear expansion coefficient	$\alpha \approx 16 \times 10^{-6} 1/K$
Bending Radius	min. 150 mm
Available lengths	32m (up to 70m on request)
Weight of the magnetic tape	ca. 62 g/m (inclusive adhesive tape + protective sheet)
Weight of the cover tape	ca. 19 g/m (inclusive adhesive tape + protective sheet)
Influence of external magnetic fields	External magnetic fields are not allowed to exceed 64 mT (640 Oe; 52 kA/m) at the magnetic tape surface, because it can destroy and damage the magnetic tape code.
Protection class	IP67

#### 7.1.4 Processing hint for the sticking of magnetic tapes

**Materials to stick:** The provided sticky tapes stick well on clean, dry and plain surfaces. Typical solvent for cleaning surfaces are a 50/50 mixed isopropyl-alcohol / water mixture or heptane. (Important: Please observe carefully the caution hints of the producer when using the solvent.) The surfaces of materials as copper, brass etc. should be sealed to avoid an oxidation. **Proof:** The stability of the adhesion is directly depending on the contact, which the adhesive develops to the surfaces stuck together. A high proof results in a good surface contact. **Sticking temperature:** The optimal sticking temperature is between + 21° C and 38° C. Avoid colder sticking surfaces than + 10°C, because in this case the adhesive becomes too hard and perhaps a sufficient immediate adhesion is hardly to achieve. After proper sticking the stability of the connection is ensured also when the temperature is below zero. The final tackiness of a sticking is from experience reached after approximately 72 hours (at + 21° C).

#### 7.1.5 Chemical resistance of the magnetic tape

---

##### Chemicals that show little or no impact:

- |                    |                 |               |               |
|--------------------|-----------------|---------------|---------------|
| - Formic acid      | - Glycerol 93°C | - Linseed oil | - Soybean oil |
| - cotton oil       | - Iso-Octane    | - N-Hexane    | - Lactic acid |
| - Formaldehyde 40% | - Petroleum     |               |               |

---

##### Chemicals that show weak to moderate effects:

- |            |             |                         |                                    |
|------------|-------------|-------------------------|------------------------------------|
| - Acetone  | - Petrol    | - Acetic acid 20%...30% | - Oleic acid                       |
| - Kerosene | - Acetylene | - Steam                 | - Acetic acid, glacial acetic acid |
| - Seawater | - Ammonia   | - isopropyl ether       | - Stearic acid 70°C                |

---

##### Chemicals that show a strong impact:

- |                        |                    |                |                               |
|------------------------|--------------------|----------------|-------------------------------|
| - Benzene              | - Nitric acid      | - Turpentine   | - Paint solvents              |
| - Carbon tetrachloride | - Trichlorethylene | - Nitrobenzene | - Hydrochloric acid 37%, 93°C |
| - Tetrahydrofuran      | - Toluene          | - Xylene       |                               |
-



## 8 Interferences

The following chapters describe possible causes for malfunction and the instructions to correct them.

### 8.1 Safety

**WARNING!**

Risk of injury by improper disposal!

Improper disposal can lead to severe disturbance to persons or property.

Therefore:

- Any work to rectify the fault may be performed only by qualified and adequately instructed personnel
- Before starting to work ensure sufficient space of mounting
- Paying attention to orderliness and to cleanliness at the mounting area, loose parts and tools, which are lying on each other or lying around, are sources of accidents

If components need to be replaced:

- Pay attention of proper mounting of the spare parts
- Install all fasteners correctly again
- Before restarting ensure that all covers and guards are properly installed and working correctly

### 8.2 Restarting after fault Clearance

Once you resolve the failure:

1. Where appropriate, reset the emergency stop device
2. Where appropriate reset the fault message to the parent system
3. Ensure that there are no persons in the danger zone
4. Proceed in accordance with the instruction of section 6

## 9 Maintenance

The device is maintenance-free.

**WARNING!**

Hazard due to improper maintenance!

Improper maintenance can result to serious personal injury or property damage.

Therefore:

Maintenance work must be performed only by qualified and authorized by the operator and instructed personnel.

## 10 Cleaning

**WARNING!**

The system should be cleaned with damp cloth, do not use aggressive cleaning products.

**ADVERT**

The surface of the magnetic tape can be cleaned with string contamination by dust, shavings, humidity, etc. occasionally with a soft cloth.

With a strong pollution of the magnetic tape by magnetic metal shavings measurement errors or malfunctions are possible.

## 11 Type Designation



**Serie/Type:**

EMIX23 Measuring system

**Version No.:**

000 = Standard

001 = 1. Special Version

002 = 2. Special Version

...

**Signal cable length:**

01.5 = 1,5m (Standard cable length)

other lengths on request

**Resolution:**

0001 = 0,001 mm (Standard)

**Supply:**

00 = 10-30 VDC /10-30 VDC

01 = 10-30 VDC /5V-TTL Line Driver

11 = 5 VDC /5V-TTL Line Driver

**Options:**

D1 = Connection via D-SUB 9-pin (Pin-Assignment in Elgo Standard)

L = Vertical Mounting (Circuit board and Sensor mounting)

### **Accessories:**

**Magnetic tape MB20-20-10-1-R:**

- 0,2 m Minimum length
- Maximum length theoretical unlimited
- Cover tape is included in delivery

## 12 Index

Accessories.....	19	Magnetic Tape.....	14
Cause of Risks.....	5	Maintenance.....	18
Content.....	2	Operational Environment.....	11
Conventional Use.....	6	Pin Assignment.....	13
Demounting.....	4	Product Features.....	8
Dimensions.....	10	Protective Equipment.....	5
Disposal.....	4	Resolutions.....	8
Document History.....	20	Safety.....	5, 17
Explanation of Symbols.....	3	Safety Instructions.....	3
General.....	3	Storage.....	7
Guarantee.....	4	Technical Data.....	9
Initial Start-up.....	11	Transport.....	7
Installation.....	11	Type Designation.....	19
installation Possibilities.....	10	Warning notices.....	3
Installation Sensor head.....	13	Warranty.....	4
Interferences.....	12, 17		

## 13 Document History

Rev.	Date	Author	Description
0	10.03.10	CN	Document created

